

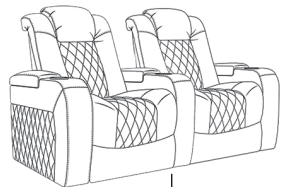

Instruction Manual

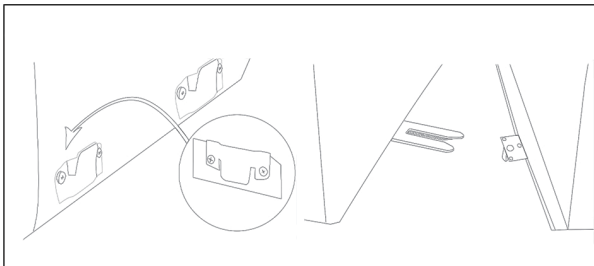

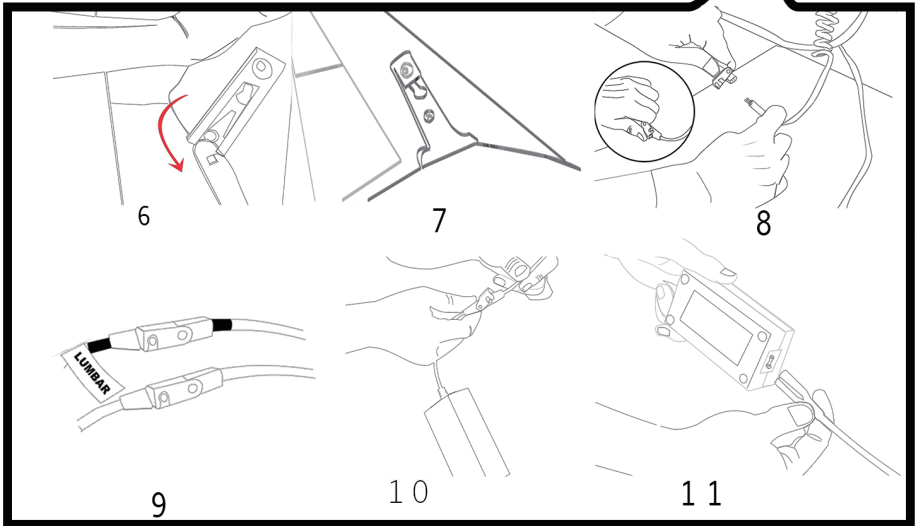
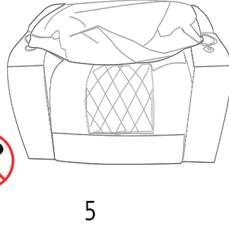
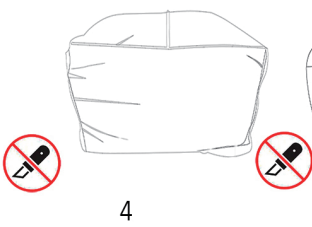
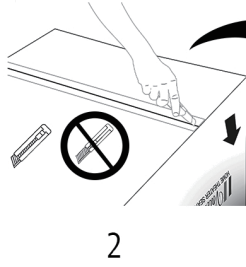
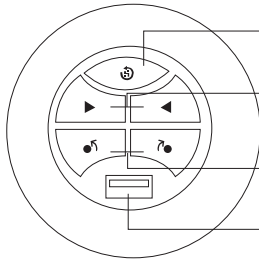

Reset Chair / LED Function

Recline Function

Headrest Function

USB Port

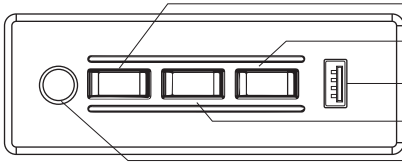

Headrest Function

Footrest Function

USB Port

Lumbar Function

Light Function

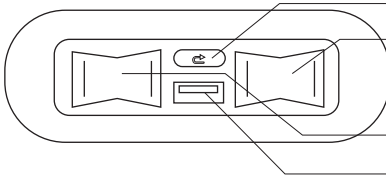

Reset Chair / LED Function

Headrest Function

Recline Function

USB Port

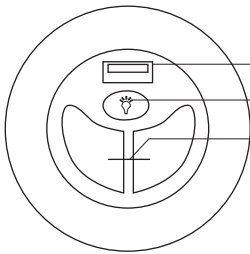

USB Port

LED Function

Recline Function

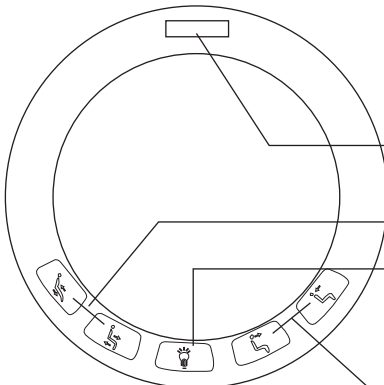

USB Port

Recline Function

LED Function

Headrest Function

Attention

1. To avoid damage to flooring while moving the sofa, place felt or soft fabric beneath each foot.
2. Avoid jumping directly on the seat cushions as it can damage the foam reducing comfort and performance.
3. Refrain from using any cutting tools or things with sharp edges near the surface of the sofa as to avoid scratching or puncturing the fabric.
4. To avoid color fading, keep the sofa from direct, sustained sunlight. For sofas in a sunny room, rotate the position to prevent uneven fading over time due to sunlight.
5. Be aware that excessive humidity and moisture can reduce the longevity of the fabric of the sofas. Humidity causes the textile to expand and contract and damages the elasticity overtime, can damage the color and result in mildew.
6. Use a clean, soft cloth to wipe any stains. Vacuum the gap between the back, armrest and seat. **DO NOT** use wet cloths, hard objects, acid, alkali, or any other chemicals on the upholstery. Using these items will damage the surface quality and lifespan.
7. New leather upholstery will soften after use. Do not be alarmed by faint sounds made when using the new sofa, it is normal. To help soften new leather, oil specific to upholstery can be used. However, it is recommended to let the leather soften over time and use rather than over oil the sofa.
8. If you have any questions, please feel free to contact our support team. We appreciate your purchase. Your feedback is important to us! Thank you for choosing our sofa!

For Assembly Video



Wall Distance required for full recline: **13cm**

Minimum Door Width **64cm**

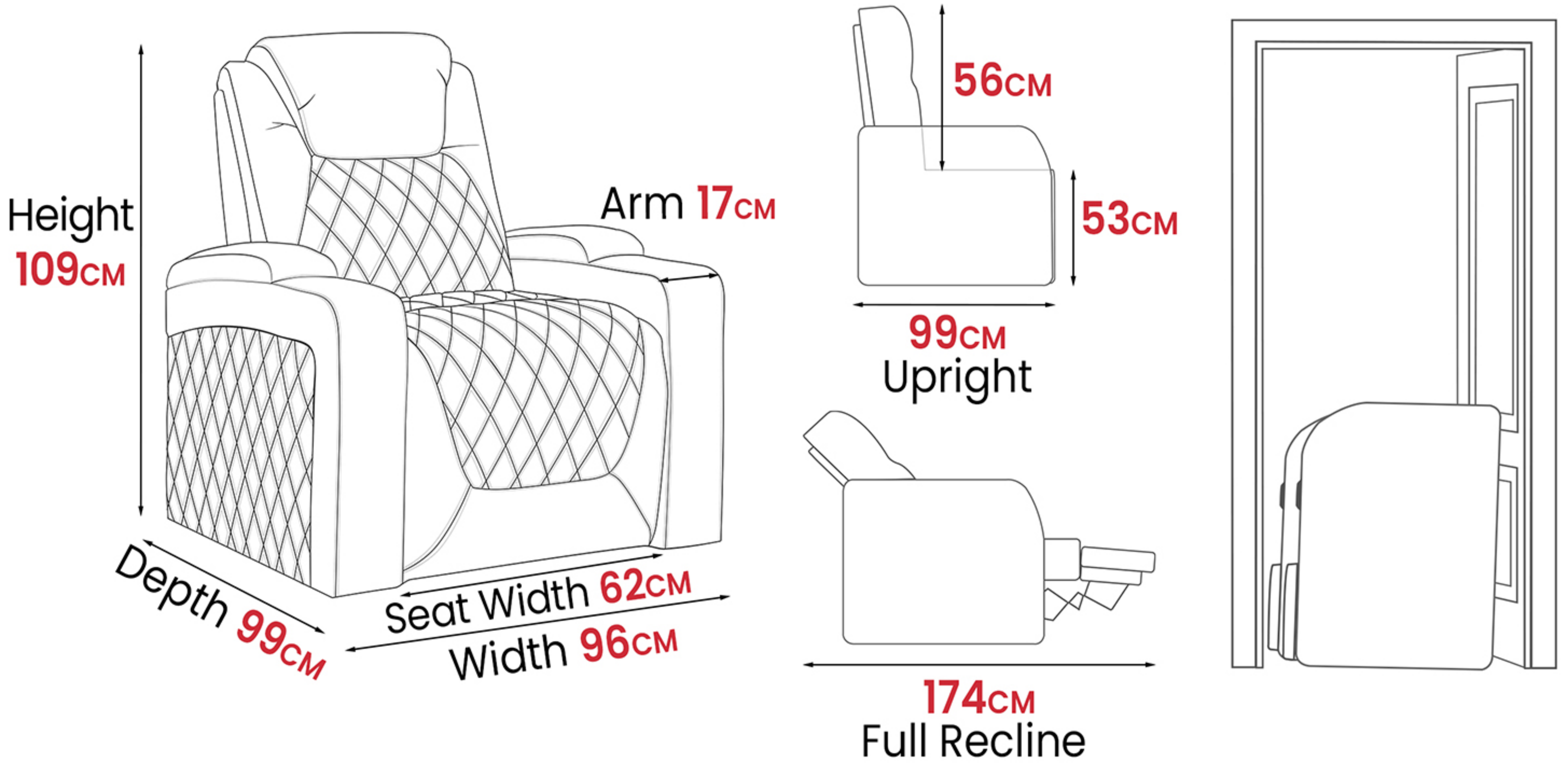

Popular Configurations

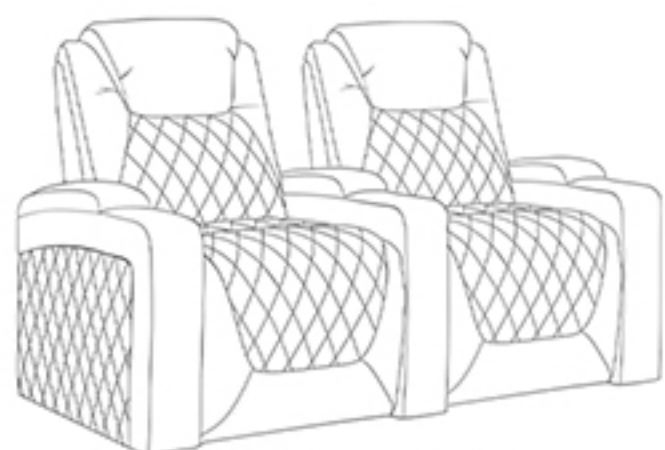

Row of 2
Width **175cm**

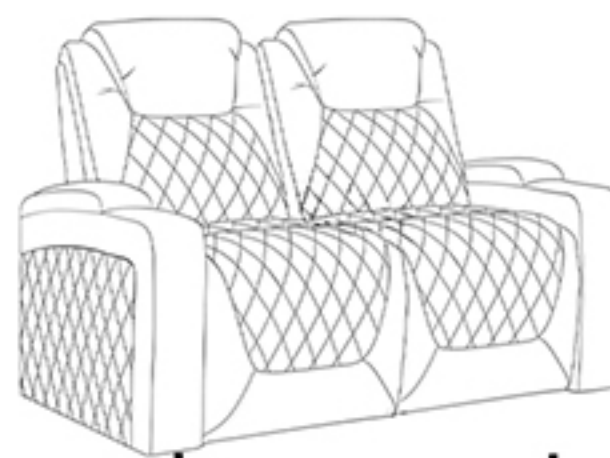

Loveseat
Width **157cm**

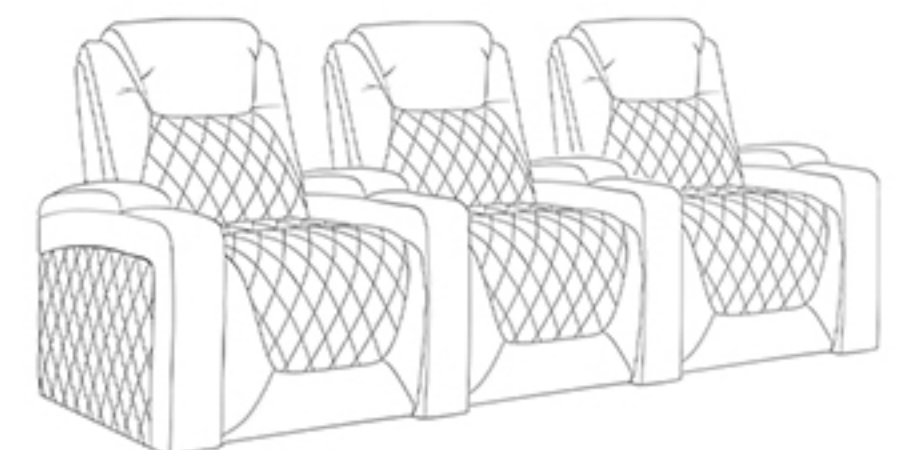

Row of 3
Width **253cm**

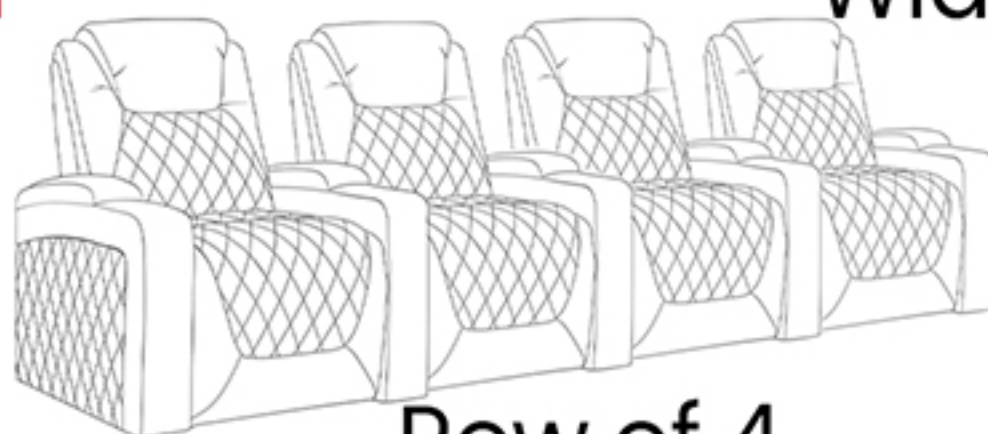

Row of 4
Width **332cm**

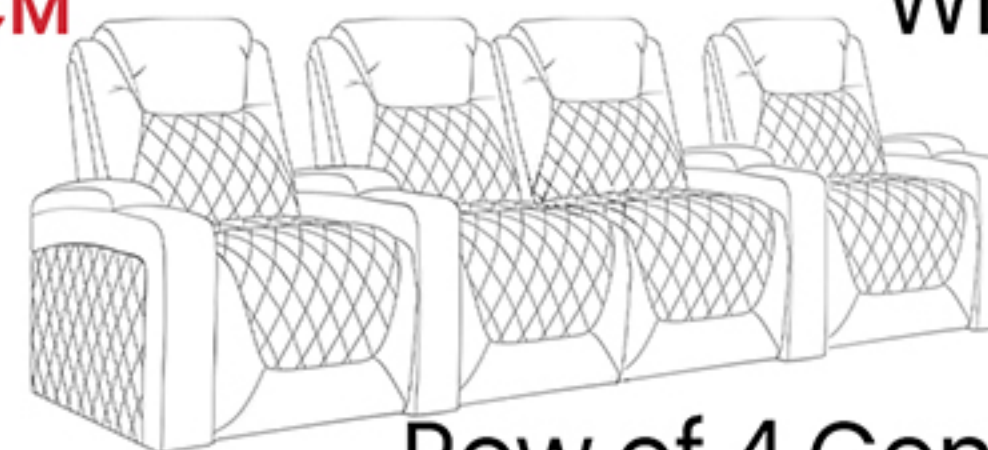

Row of 4 Center
Loveseat Width **315cm**

Premium Italian Top Grain Leather

Nappa 11000 Leather

Motorized Headrest

Comfort your neck

Motorized Lumbar Support

Perfect back support

Hidden Storage

Best place for the remotes

Sleek LED Cupholder

Find your drink in the dark

Built-in Accessory holder

Removable optional accessories

USB Charger

Conveniently charge your devices

Ambient Base Lighting

Find your seat in the dark





Premium Italian Top Grain Leather

Nappa 11000 Leather

Motorized Headrest

Comfort your neck

Motorized Lumbar Support

Perfect back support

Hidden Storage

Best place for the remotes

Sleek LED Cupholder

Find your drink in the dark

Built-in Accessory holder

Removable optional accessories

USB Charger

Conveniently charge your devices

Ambient Base Lighting

Find your seat in the dark